



## 柵本体

### ● 寸法図

平面図

側面図

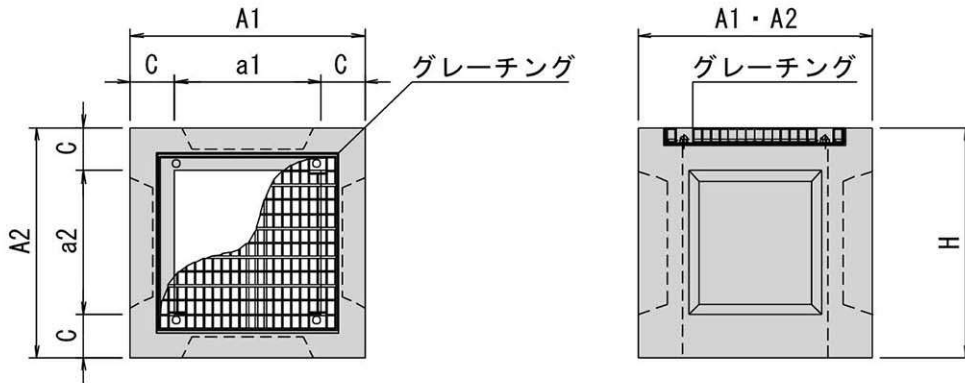

(注意)

1. 施工時はノックアウト(薄肉部)をコンクリートで充填してください
2. 最終仕上がり前に直接荷重をかけないで下さい。カド欠け等の原因となります

集水柵類 6

### ● I 型 諸元表 (C=150) T-25

呼び名	参考重量 (kg)	寸法 (mm)					
		A1	A2	a1	a2	H (基本高)	H (製造可能範囲)
FM - 30	435	600	600	300	300	700	400 ~ 700
FM - 30×40	483	600	700	300	400	700	400 ~ 700
FM - 30×50	531	600	800	300	500	700	400 ~ 700
FM - 30×60	580	600	900	300	600	700	400 ~ 700
FM - 35	483	650	650	350	350	700	400 ~ 700
FM - 35×60	604	650	900	350	600	700	400 ~ 700
FM - 40	531	700	700	400	400	700	400 ~ 1000
FM - 40×50	580	700	800	400	500	700	400 ~ 700
FM - 40×60	628	700	900	400	600	700	400 ~ 700
FM - 45	662	750	750	450	450	800	500 ~ 1000
FM - 50	718	800	800	500	500	800	500 ~ 1200
FM - 50×70	1035	800	1000	500	700	1000	700 ~ 1500
FM - 60	1035	900	900	600	600	1000	700 ~ 1500
FM - 70	1408	1000	1000	700	700	1200	900 ~ 1200
FM - 80	1573	1100	1100	800	800	1200	900 ~ 1500
FM - 90	2174	1200	1200	900	900	1500	1200 ~ 1500
FM - 100	2381	1300	1300	1000	1000	1500	1200 ~ 1500
FM - 120	2795	1500	1500	1200	1200	1500	1200 ~ 1500

### ● II 型 諸元表 (C=200) T-25

呼び名	参考重量 (kg)	寸法 (mm)					
		A1	A2	a1	a2	H (基本高)	H (製造可能範囲)
FM - 40 - II	773	800	800	400	400	700	400 ~ 1000
FM - 50 - II	1288	900	900	500	500	1000	700 ~ 1500
FM - 60 - II	1472	1000	1000	600	600	1000	700 ~ 1500
FM - 70 - II	1987	1100	1100	700	700	1200	900 ~ 1500
FM - 80 - II	2208	1200	1200	800	800	1200	900 ~ 1500
FM - 90 - II	2429	1300	1300	900	900	1200	900 ~ 1500
FM - 100 - II	3312	1400	1400	1000	1000	1500	1200 ~ 1500
FM - 120 - II	3864	1600	1600	1200	1200	1500	1200 ~ 1500

※ スロープ型・コンクリート蓋仕様も製造可

※ 高さ・開口位置など御相談下さい

※ 上記以外のサイズ要相談



## 特殊プレキャスト柵

### ● 寸法図

【本体】

平面図

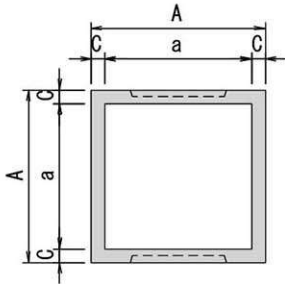

側面図

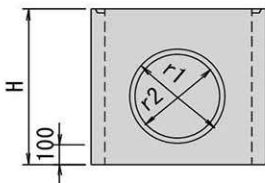

【調整柵】

平面図

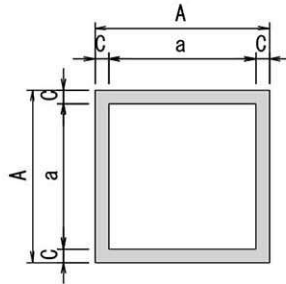

側面図

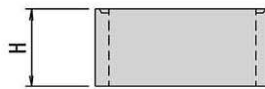

【蓋板】

平面図 ※2枚1組

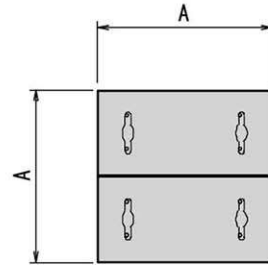

側面図



### ● 諸元表

呼び名	種類	参考重量 (kg)	寸法 (mm)							ヒューム管取付
			A	H	a	c	t	r1	r2	
3号柵 750×750	本体	343	890	800	750	70	-	490	470	φ350~φ400
	調整柵	112	890	200	750	70	-	-	-	-
	蓋板	95×2	890	-	-	-	100	-	-	-
4号柵 1000×1000	本体	693	1160	1000	1000	80	-	800	700	φ600以上
	調整柵	149	1160	200	1000	80	-	-	-	-
	蓋板	162×2	1160	-	-	-	100	-	-	-

## L型柵

### ● 寸法図

平面図 (参考重量: 304kg)

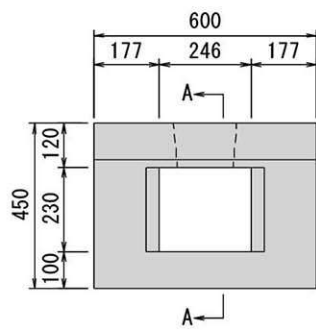

側面図

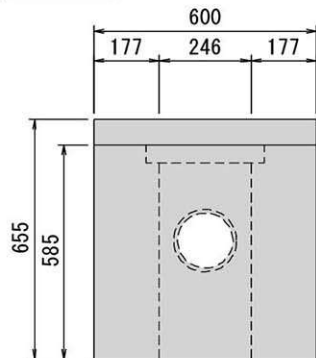

A-A 断面図

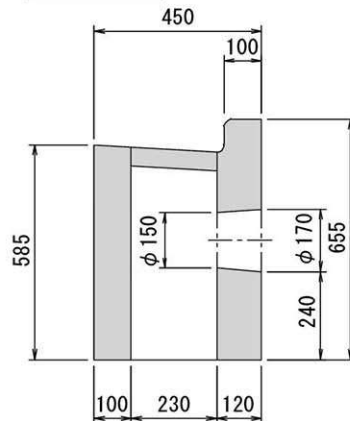

6 集水柵類



## 熊本市型集水柵 (T-25)

● 寸法図 (参考重量 : 175kg)

平面図

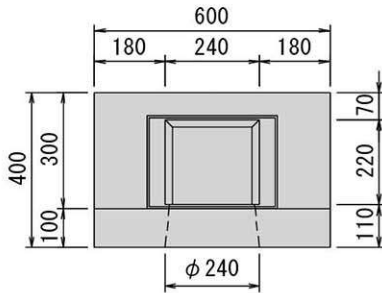

正面図

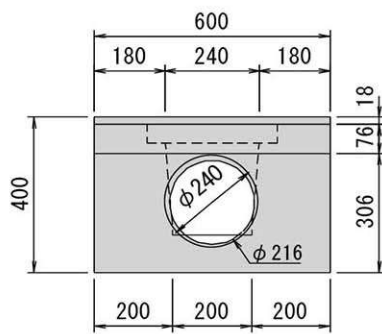

側面図

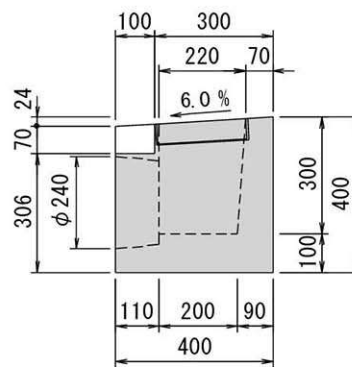



### 本体

#### ● 寸法図

平面図

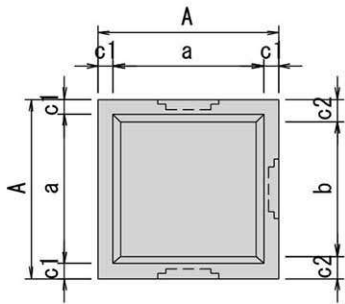

側面図

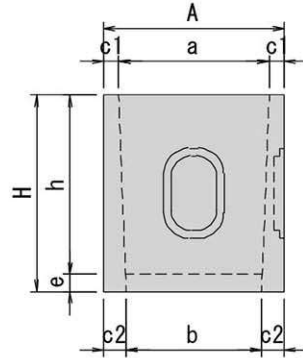

(特記)

※ 底無製品の製品高は h になります

※ グレーチング蓋対応可

#### ● 諸元表

呼び名	参考重量 (kg)		寸法 (mm)							
	底付	底無	A	H	a	b	c1	c2	e	h
240	37	31	300	330	240	220	30	40	30	300
300	53	43	360	395	300	270	30	45	35	360
360	86	69	430	455	360	330	35	50	40	415
400	101	80	470	500	400	360	35	50	50	450
450	135	106	520	550	450	410	35	55	45	505
500	189	153	580	605	500	450	40	65	45	560
600	282	221	680	710	600	540	40	70	55	655

6 集水枒類

### 蓋板

#### ● 寸法図

平面図

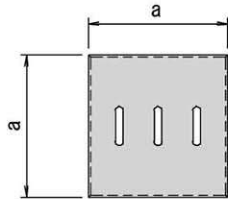

側面図

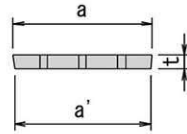

#### ● 諸元表

呼び名	参考重量 (kg)	寸法 (mm)		
		a	a'	t
240	7	300	295	30
300	10	360	350	35
360	14	420	410	40
400	21	470	460	40
450	26	520	510	45
500	37	580	570	50
600	55	680	670	55

### 蓋受

#### ● 寸法図

平面図

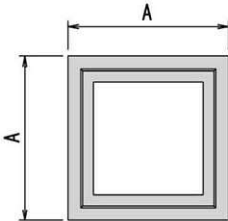

側面図

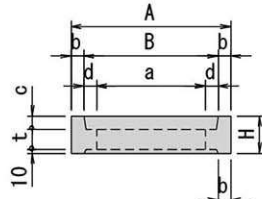

#### ● 諸元表

呼び名	参考重量 (kg)	寸法 (mm)							
		A	B	H	a	b	c	d	t
240	17	380	310	100	240	35	30	35	60
300	19	440	370	100	300	35	35	35	55
360	22	500	430	100	360	35	40	35	50
400	28	550	480	100	400	35	40	40	50
450	46	650	570	110	450	40	48	40	52
500	47	700	610	110	500	45	53	45	47
600	54	800	710	110	600	45	58	45	42

### 補助枒

#### ● 寸法図

平面図

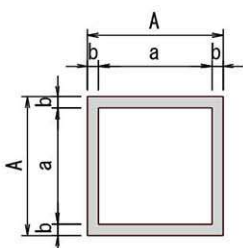

側面図

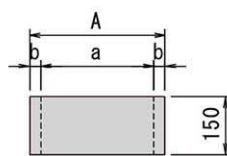

#### ● 諸元表

呼び名	参考重量 (kg)	寸法 (mm)		
		A	a	b
240	12	300	240	30
300	14	360	300	30
360	20	430	360	35
400	22	470	400	35
450	24	520	450	35
500	31	580	500	40
600	37	680	600	40



## 本体

### ● 寸法図

平面図

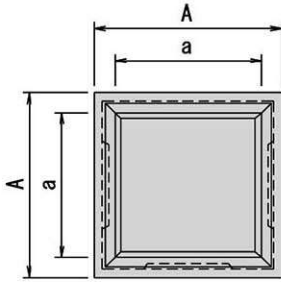

側面図

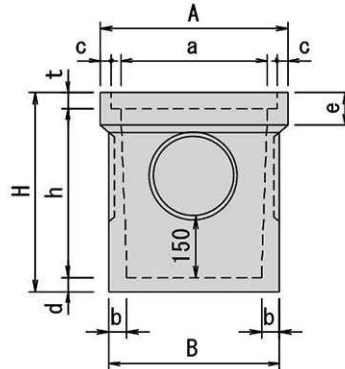

### ● 諸元表

呼び名	参考重量 (kg)	寸法 (mm)									
		A	B	H	a	b	c	d	e	h	t
180	15	270	220	290	180	30	25	20	60	240	30
240	30	330	290	355	240	35	25	25	65	300	30
300	43	390	350	415	300	25	25	25	80	360	30
360	78	460	420	495	360	45	27	30	80	420	40
420	90	520	480	495	420	45	27	30	80	420	45
450	106	550	510	525	450	45	27	30	80	450	45
600	237	750	670	690	600	70	30	35	100	600	55

集水柵類 6

## 蓋板

### ● 寸法図

平面図

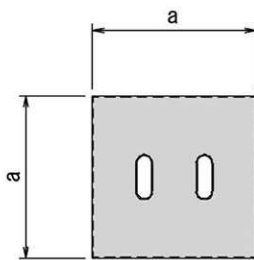

側面図

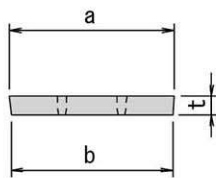

### ● 諸元表

呼び名	参考重量 (kg)	寸法 (mm)		
		a	b	t
180	3	210	205	30
240	5	270	265	30
300	8	330	325	30
360	14	395	390	40
420	21	455	450	45
450	24	485	480	45
600	55	680	670	55

## 調整柵

### ● 寸法図

平面図

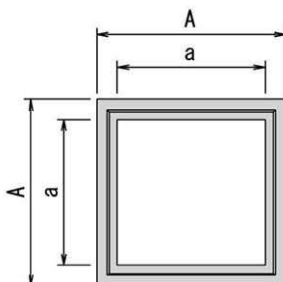

側面図

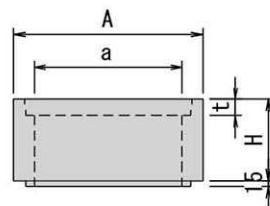

### ● 諸元表

呼び名	参考重量 (kg)			寸法 (mm)		
	H=100	H=150	H=200	A	a	t
180	8	12	-	270	180	30
240	11	16	-	330	240	30
300	13	19	-	390	300	30
360	-	-	36	460	360	40
420	-	-	41	520	420	45
450	-	-	44	550	450	45
600	-	-	97	750	600	55